



# Conserve energy as you produce both strong acidic water and strong Kangen Water®

**Point 1**

## An energy-saving machine that allows you to easily produce strong acidic water and strong Kangen Water®

It is possible to produce a good amount of electrolyzed water of which the value of ORP is included in the range of +1130mV and -800mV and which boasts of good effects, by loading an electrolytic cell with four electrode plates that use electrodes made of platinum plated titanium. (That depends on the choice of resulting water and original water)  
The Kangen water contains a lot of hydroxide ions (OH<sup>-</sup>) and positive ions (such as calcium ions) produced by electrolysis, and it also contains hydrogen.

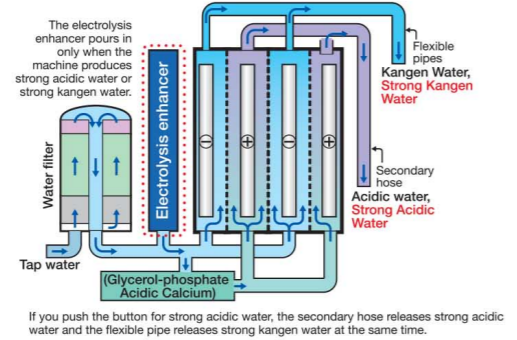

**Point 2**

## Equipped with an electrolysis enhancer tank Strong Acidic Water and Strong Kangen Water produced steadily and continuously.

The built-in tank for the electrolysis enhancer saves you the trouble of putting in the electrolysis enhancer which is necessary to obtain strong acid water and strong kangen water, and allows you to produce those kinds of water steadily and continuously that has excellent effects.

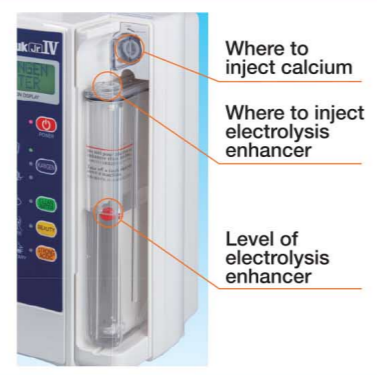

**Point 3**

## You will be guided by a large-sized liquid crystal display (LCD). Easy to use one-touch panel.

A clear, large-sized LCD will inform you of the water being produced (Kangen Water®, acidic water, strong acidic water®, or clean water) and other necessary information. The operation is easy with the touch of a button to power up or select the type of water you would like.

\*When you push the button for strong acidic water, the secondary hose releases strong acidic water and the flexible pipe releases strong kangen water at the same time.

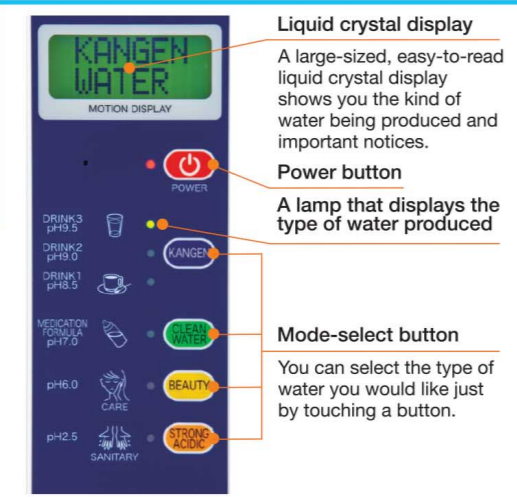

### The three-layered, high-powered water-cleaning filter creates delicious water

Enagic's triple layer filter, with a spherical antibacterial active carbon that meets NSF guidelines, is composed of a mechanical filter and calcium bi-sulfite, which is approved as a food additive (in some countries there may be exceptions). It produces healthy water and removes chlorine, rust, muddiness, and does not eliminate important minerals. Filter change will be notified by the LCD alarm. (Jr.II DX does not have sound notification)



With the one-touch convenience of the diverter, change between



ION Clean Water



TAP Tap water Shower



TAP Tap water (Straight)

### Faucet types and diverter

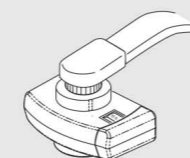

Faucet with an inner screw Corporation cock B.

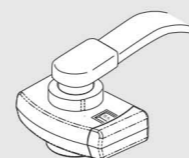

Faucet with an outer screw Only the corporation cock B.

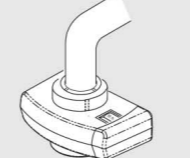

Faucet with a puffed end Only the corporation cock B.

### Scale drawing mm

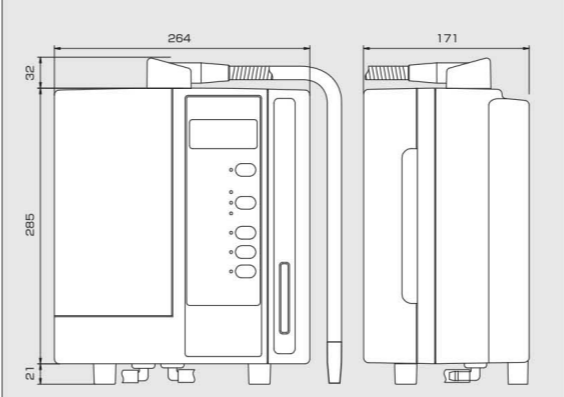

Gross Weight (wet) : 5.3kg

### Standard Specifications

MODEL NAME · NUMBER	Leveluk JrIV TYH-251	FILTERING MEDIUM	Activated Charcoal
POWER SUPPLY	AC 120V or AC 220-240V	WATER FILTER	INITIAL CHLORINE REMOVAL
POWER CONSUMPTION	Approximately 160W (under maximum electrolysis function)		
SYSTEM	Continuous Ionized Electrolysis Water Generator System (with built-in flow rate sensor)	ELEMENTS NOT REMOVABLE	Metallic ions and/or salinity present in original (tap) water
PRODUCTION RATE	Kangen Water : 2.0-3.0L / min. Strong Acidic Water : 0.5-1.0L / min.	APPLICABLE WATER QUALITY AND PRESSURE	Municipally supplied drinking water: Dynamic range in 100-450 kPa
		ELECTROLYSIS ENHANCER	Solution additive pump system
LEVEL SELECTIONS	<ul style="list-style-type: none"> <li>●Kangen water /3 levels (approx. pH8.5-9.5)</li> <li>●Clean water (neutral)</li> <li>●Acidic water (approx. pH5.5-6.5)</li> <li>●Strong Acidic water (approx. pH2.4-2.7)</li> <li>●Strong Kangen water (approx. pH11.0-)</li> </ul>	ENHANCER REFILLING	Indicates by buzzer and LCD
		PROTECTOR	Current Limiter/Voltage Stabilizer/Thermal Protection
ELECTROLYSIS CAPABILITY UNDER CONTINUOUS USE	Approx. 30 min. at normal room temperature.		
CELL CLEANING METHOD	Auto cleaning system (periodically controlled by microcomputer).		
ELECTRODE MATERIAL	Platinum-plated Titanium		

### SAFETY PRECAUTIONS For your own safety, be sure to observe the following precautions

<p><b>WARNING</b></p> <ul style="list-style-type: none"> <li>● Please read the Operation Manual carefully, and follow all instructions.</li> <li>● Pay strict attention to the following points before consuming Ionized alkaline water (KANGEN WATER®): <ul style="list-style-type: none"> <li>(1) Do not take medicine(s) with KANGEN WATER®.</li> <li>(2) Those with acidity conditions should not consume KANGEN WATER®.</li> <li>(3) Should you experience any abnormal feelings after consuming</li> </ul> </li> <li>● KANGEN WATER®, discontinue use immediately. Also, consult with your physician prior to consuming KANGEN WATER® Should you have any concerns.</li> <li>● Those under the care of a physician should consult with their physician before consuming KANGEN WATER®.</li> <li>● Those with sensitive skin or allergies should consult their physician before consuming KANGEN WATER®.</li> <li>● Those with allergic reactions or sensitivity to acidic water should consult their physician.</li> </ul>	<p><b>CAUTION</b></p> <ul style="list-style-type: none"> <li>● For those drinking KANGEN WATER® for the 1st time: It is recommend the you start drinking KANGEN WATER® at 8.5pH with 1-2 glasses/day for on week.</li> <li>● You can then gradually increase the pH level.</li> <li>● Should you experience a rash after drinking KANGEN WATER®: Those with allergies to certain foods may experience rash-like symptoms. Consult with your physician.</li> <li>● Use municipally-treated tap water.</li> </ul>
--	---

● The specifications or appearance of the product are subject to manufacturer's improvements without prior notice.  
● Please be aware that actual products may differ slightly in color, etc from that seen in print.  
● For more information about the product, please inquire with the sales dealer in your district or area.  
● Every product has an accompanying warranty card, which shall be filled in and issued by the Representative Sales Firm. Please check the contents and keep it in safe place for later use during the period of warranty.

Distributor

**Enagic India Kangen Water Pvt. Ltd.**  
The Millenia Tower - B, 4th Floor, Unit - 401,  
No.1&2, Murphy Road, Ulsoor,  
Bangalore - 560008. Karnataka - India.

# Revolutionize your lifestyle with water

Change your water...  
change your life™  
Eco-friendly daily water

- High performance with four electrode plates
- Equipped with a built-in electrolysis enhancer tank
- You will be prompted by a large LCD display

The power of Kangen water preserves your body and the environment!

**Leveluk JrIV**  
Continuous Ionized Electrolysis Water Generator



# Customize your pH levels with 5 types of water to enhance your body, life, and environment.

**Sanitary water**

**Strong Acidic Water** pH2.5 and below ⚠️※not suitable for drinking

STRONG ACIDIC button from the secondary hose (At the same time, Strong Kangen Water will be released from the flexible pipe.)

pH2.5 Push

**Cleaning and Disinfecting Power**

Excellent disinfecting power

**Excellent cleaning and disinfecting power** Strong Acidic Water has excellent disinfecting power that help prevent food poisoning. Use it to clean & sterilize your produce, meat and cookware.

**What is Strong Acidic water?**

Strong Acidic Water is a type of electrolyzed water containing hypochlorous acid produced by the anodes. It is produced as a result of adding electrolysis enhancer to the electrolysis reaction. In general, the pH is below 2.7, and the ORP is over 1,100mV. It is not a strong acidic chemical substance.

- To sanitize knives, cutting boards and dish towels
- To disinfect your hands.
- To disinfect your toothbrushes
- To clean your skin
- To remove tea and coffee stains
- To eliminate odors



**Environmentally friendly water**

**Strong Kangen Water** pH11.0 and higher ⚠️※not suitable for drinking

STRONG ACIDIC button from the flexible pipe (At the same time, Strong Acidic Water will be released from the secondary hose.)

pH2.5 Push

**Cleaning Power**

It has a strong effect to dissolve and clean materials.

**Super Swelling Power**

It softens materials quickly.

**Dissolving Power**

It has a strong power to dissolve and draw out substances.

**Thermal Conduction**

It doesn't take long time to boil.

**What is Strong Kangen Water?**

Strong Kangen Water is a type of electrolyzed water with an electron potential containing sodium hydroxide produced by the cathode. In general, the pH is over 11.0, and the ORP is 700mV or less. It is not a strong alkaline substance.

**Strong Kangen Water packs an effective cleaning effect as a detergent preserving hygiene in your daily life.**

- To clean cutting boards, knives, and dishes
- To sterilize vegetables, meat.
- To remove slime and stains on the floor
- To remove toilet stains
- To remove stains from coffee, soy sauces
- To use for washing clothes(reduces the need for laundry detergent)
- To remove the harsh taste of wild vegetables



※ It will be still more effective to clean with strong acidic water after cleaning with strong kangen water.

**Healthy water**

**Kangen Water®** pH8.5~9.5 suitable for drinking

KANGEN button from the flexible pipe (At the same time, Acid Water will be released from the secondary hose.)

pH9.5 / pH9.0 / pH8.5 Push

**Swelling Power**

It has the power to soften substances.

**Dissolving Power**

It dissolves and draws out substances.

**Thermal Conduction**

It doesn't take a long time to boil.

**Kangen Water® improves the taste of your drinking water and food.**

- **With coffee, or tea**  
Taste and aroma are everything. Using less coffee and tea, but pulling out more flavor, you'll be amazed at the color, taste and aroma and achieve a fuller, richer taster.
- **With other strongly acidic foods**  
Drink Kangen Water® together when eating strongly acidic foods such as meat and egg. The alkaline water helps your body balance the acidic effects.
- **When making soups and stews**  
Kangen Water® draws out the flavor of ingredients so your cuisine turns out tender and juicy. You'll need less seasoning, making it perfect for people trying to reduce their intake of salt.
- **Use for washing vegetables**  
Use Kangen Water® to remove the raw taste of onions and other strong-flavored vegetables.
- **In cooking rice**  
Kangen Water® used to wash and cook rice brings out delicious and fluffy rice.



**What is ORP (Oxidation Reduction Potential)?**

ORP (Oxidation Reduction Potential) is a value that measures the proportion of oxidizing ions (such as chloride ions) and reduction ions (such as calcium ions) in a solution. If this is a negative value, this solution is an electron donor and can be easily oxidized. If this is a positive value, the solution is an oxidizing solution and can be easily reduced. This value is shown in mV(millivolt) and is used as a reference to display the degree of chemical reaction.

**Water for beauty**

**Acidic Water** pH6.0 and below ⚠️※not suitable for drinking

BEAUTY button from the flexible pipe (At the same time, Kangen Water® will be released from the secondary hose.)

pH6.0 Push

**Astringency**

It has the power to tighten substances.

**Cleaning Power**

It has the power to purify substances.

**Acidic water is especially effective in toning the skin.**

It helps to refresh the skin after a hot bath or shower and also works to close the pores after washing your face.

**For boiling pasta and making batters for frying.**

Noodles and pasta will take on a brilliant shine and improved texture as a result of boiling then in acidic water. Acidic water will also enhance the batter and crispy texture of fried foods.

**As a cleaner.**

Acidic water is effective in cleaning stains on dishes, cups, glasses, even bathroom tiles.



**Water of security**

**Clean Water** pH7.0 suitable for drinking

CLEAN WATER button from the flexible pipe (At the same time, the secondary hose also releases purified water, but please use the water released from the flexible pipe.)

pH7.0 Push

**Use clean water to take medication and make baby formula.**

The three-layered, high-power water filter removes not only chlorine but also sediment such as rust and impurities. Clean water tastes delicious and is filled with essential minerals. Clean water is best used to take medications and in making baby formula.

